

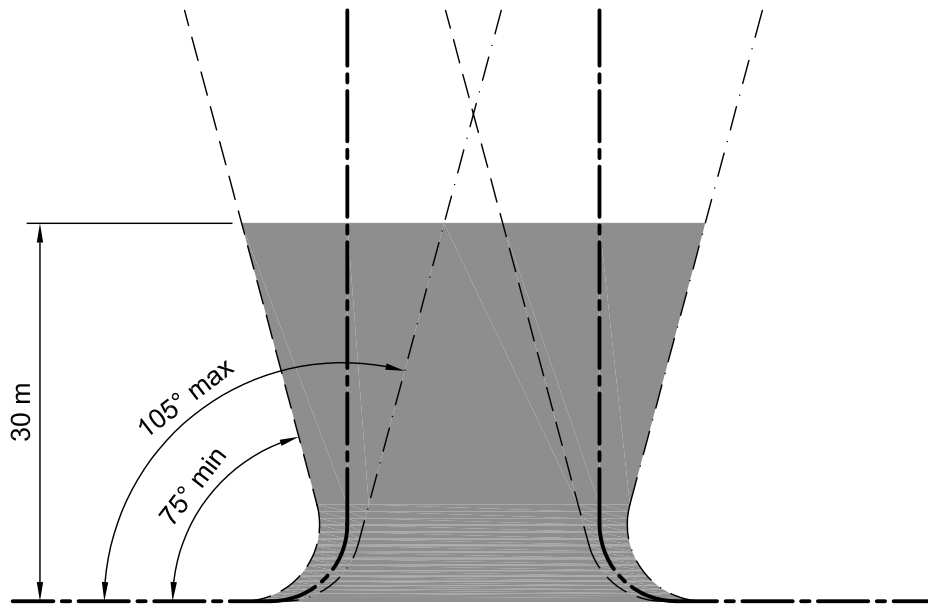

ANNEXE 1

Angle d'une intersection



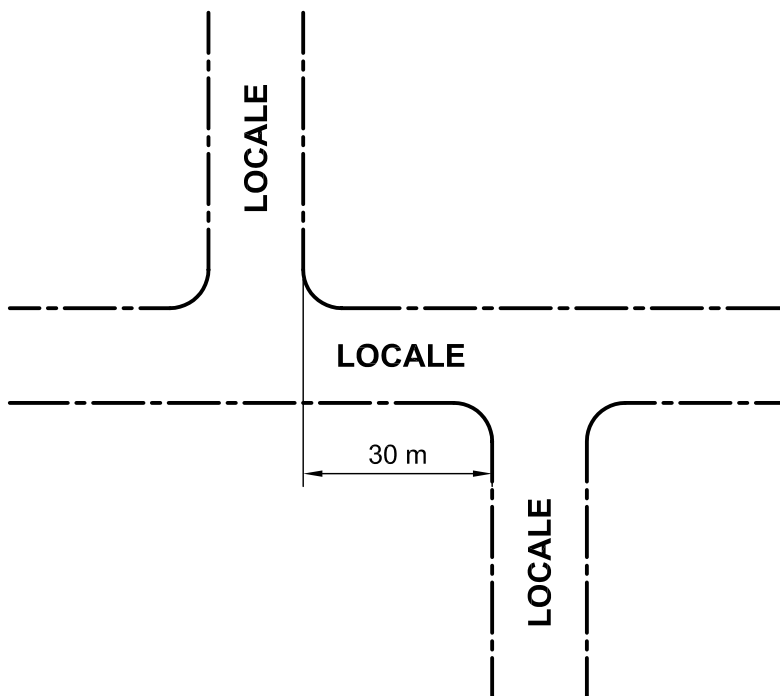
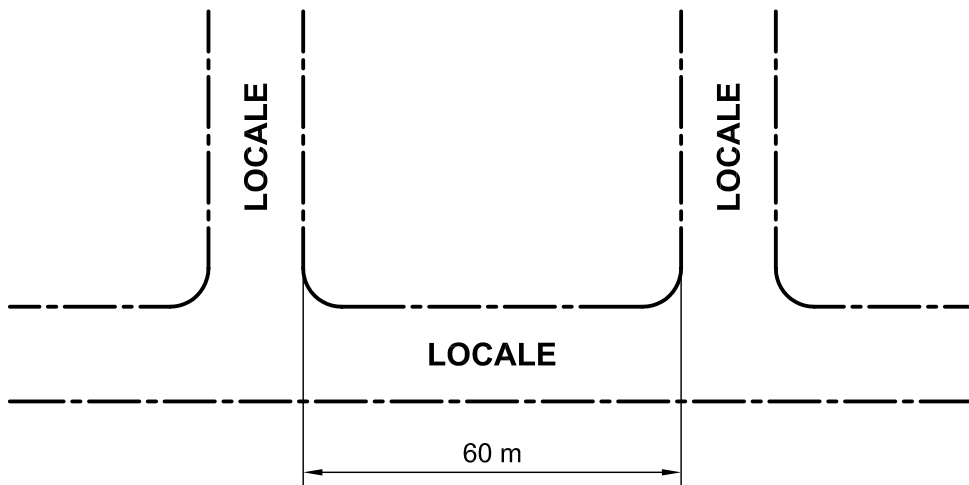

RUE

 <p>VILLE DE SAINT-JÉRÔME</p>	<u>Description</u> INTERSECTIONS Angle d'une intersection		
	<u>Règlement</u> 0310 - Lotissement	<u>Illustration (n° article):</u> 30	
<u>Annexe:</u> 1	<u>Plan no:</u> 0310-000.1	<u>Échelle:</u> Aucune	<u>Date:</u> 2010-04-01

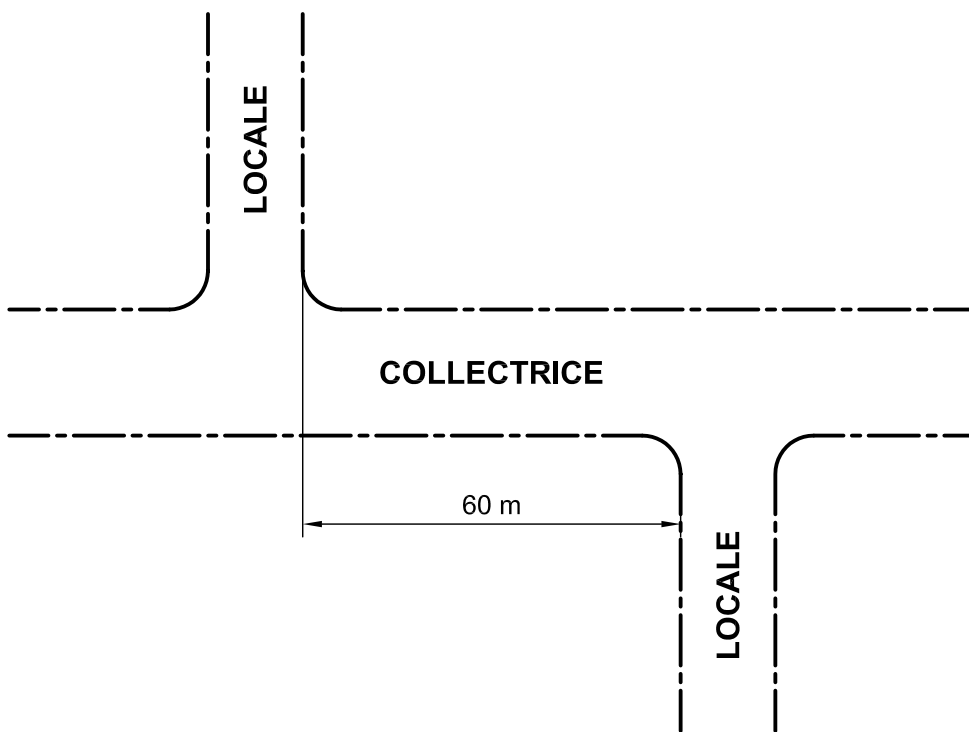
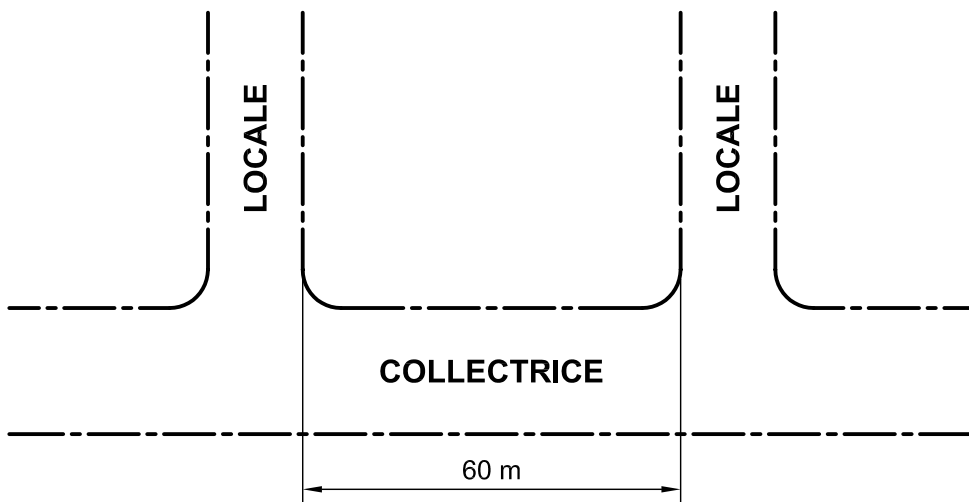

 VILLE DE SAINT-JÉRÔME	INTERSECTIONS Distance à respecter entre les voies de circulation		
	Règlement 0310 - Lotissement	Illustration (n° article): 31.1)1°	
Annexe: 1	Plan no: 0310-000.2	Échelle: Aucune	Date: 2010-04-01



 VILLE DE SAINT-JÉRÔME	INTERSECTIONS Distance à respecter entre les voies de circulation		
	Règlement 0310 - Lotissement	Illustration (n° article): 31.1)2°	
Annexe: 1	Plan no: 0310-000.3	Échelle: Aucune	Date: 2010-04-01

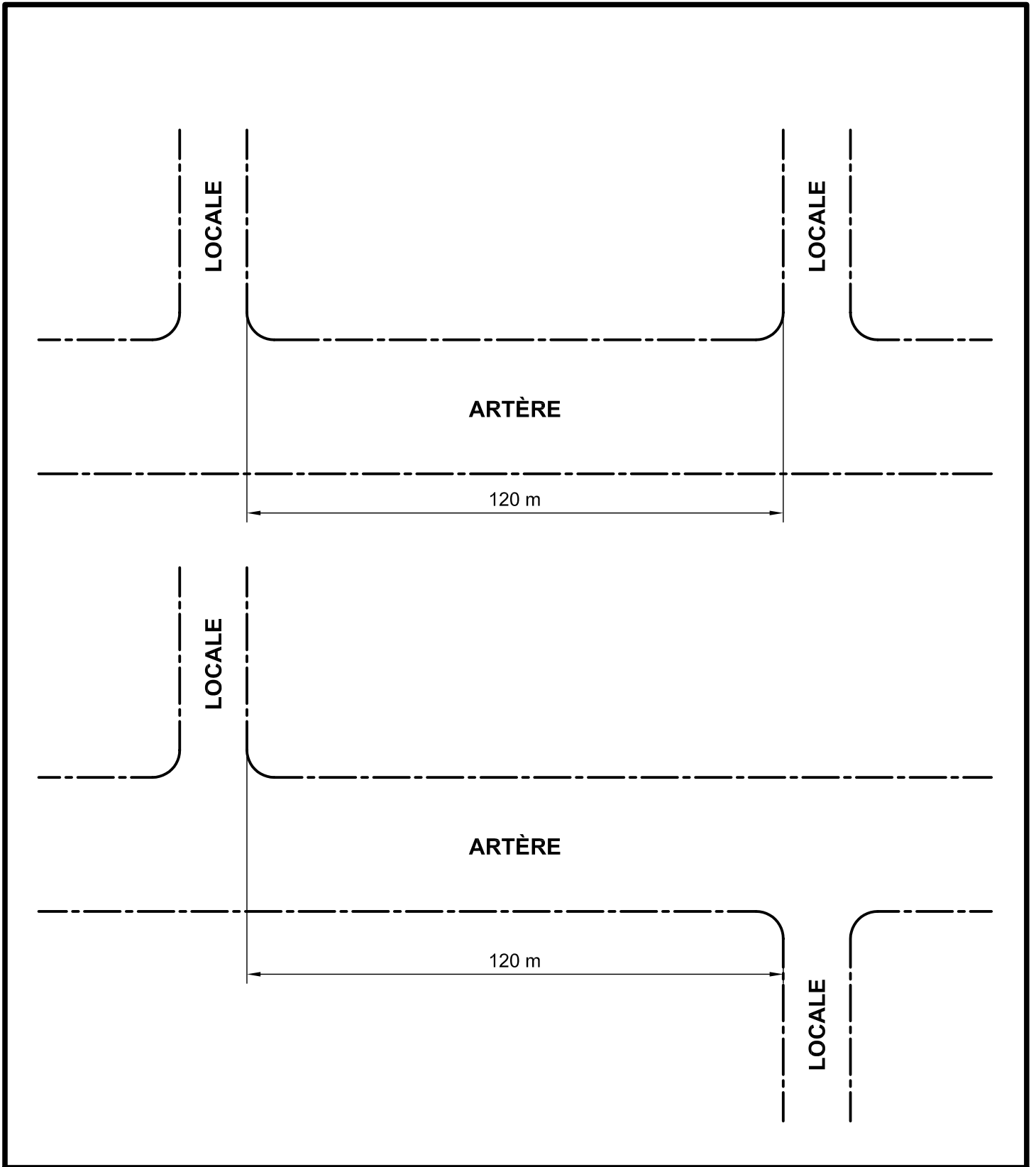

 VILLE DE SAINT-JÉRÔME	INTERSECTIONS Distance à respecter entre les voies de circulation		
	<u>Règlement</u> 0310 - Lotissement	<u>Illustration (n° article):</u> 31.1)3°	
<u>Annexe:</u> 1	<u>Plan no.:</u> 0310-000.4	<u>Échelle:</u> Aucune	<u>Date:</u> 2010-04-01

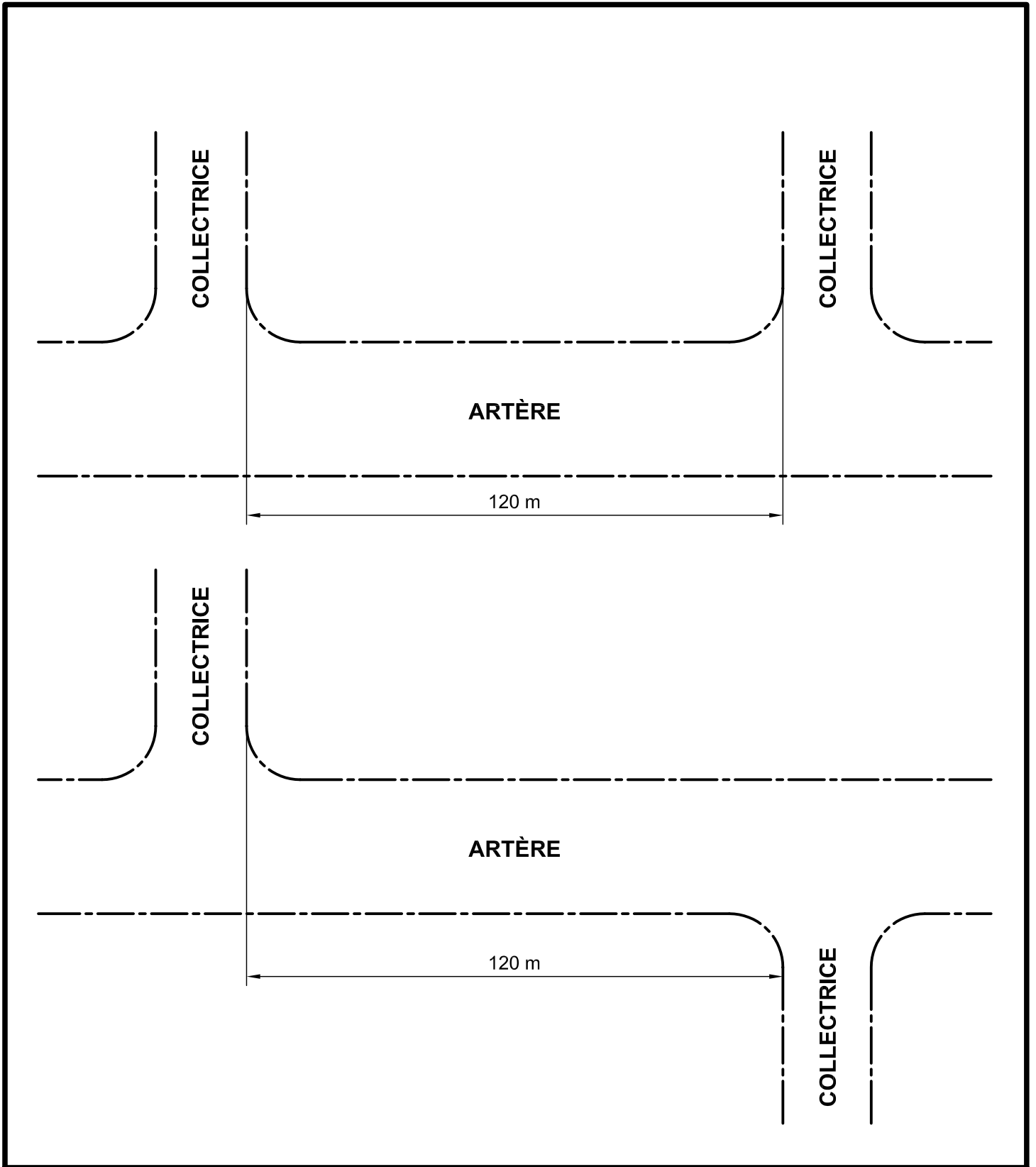

 VILLE DE SAINT-JÉRÔME	INTERSECTIONS Distance à respecter entre les voies de circulation		
	Règlement 0310 - Lotissement	Illustration (n° article): 31.1)4°	
Annexe: 1	Plan no: 0310-000.5	Échelle: Aucune	Date: 2010-04-01

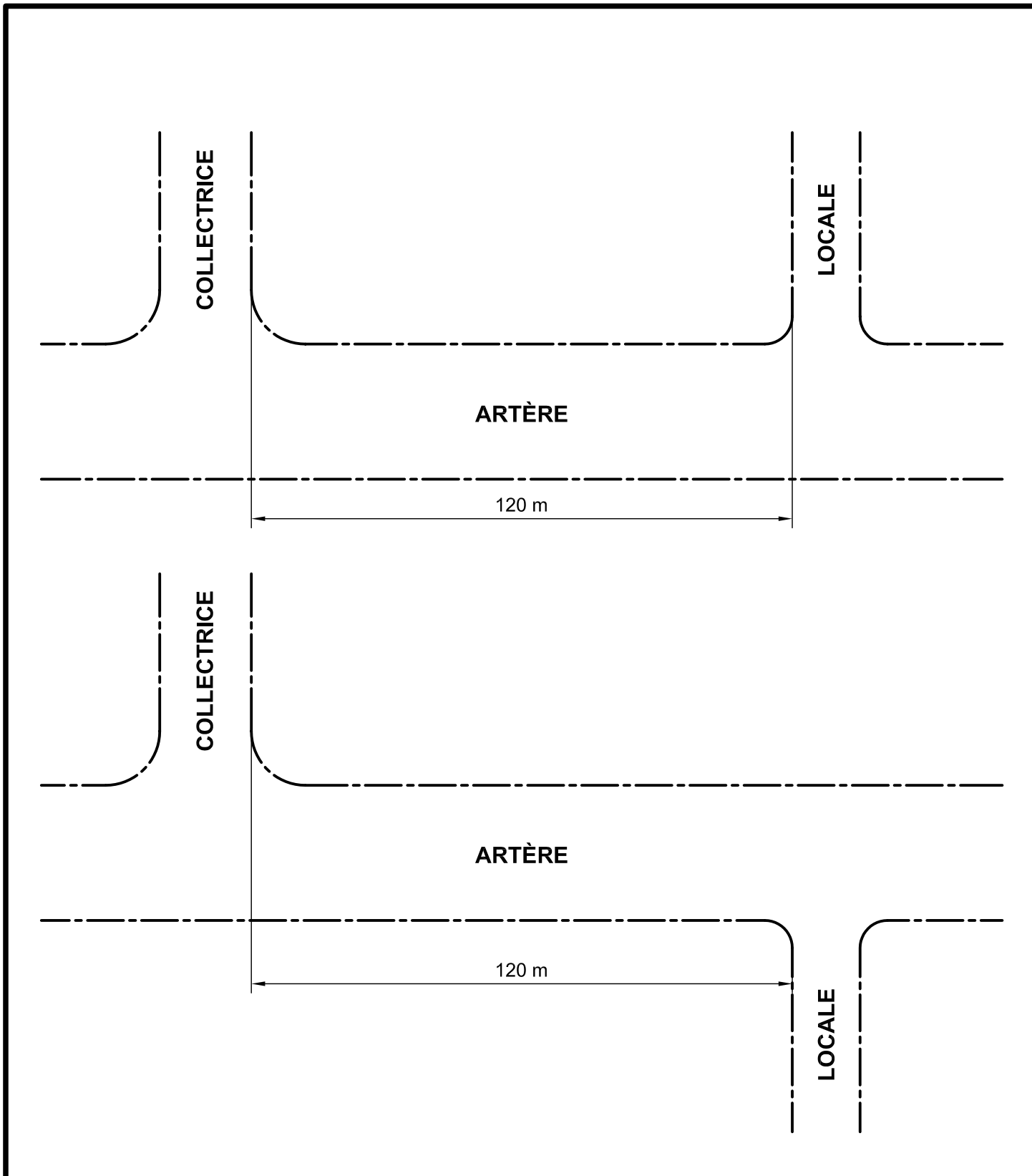

 VILLE DE SAINT-JÉRÔME	INTERSECTIONS Distance à respecter entre les voies de circulation		
	Règlement 0310 - Lotissement	Illustration (n° article): 31.1)5°a)	
Annexe: 1	Plan no: 0310-000.6	Échelle: Aucune	Date: 2010-04-01

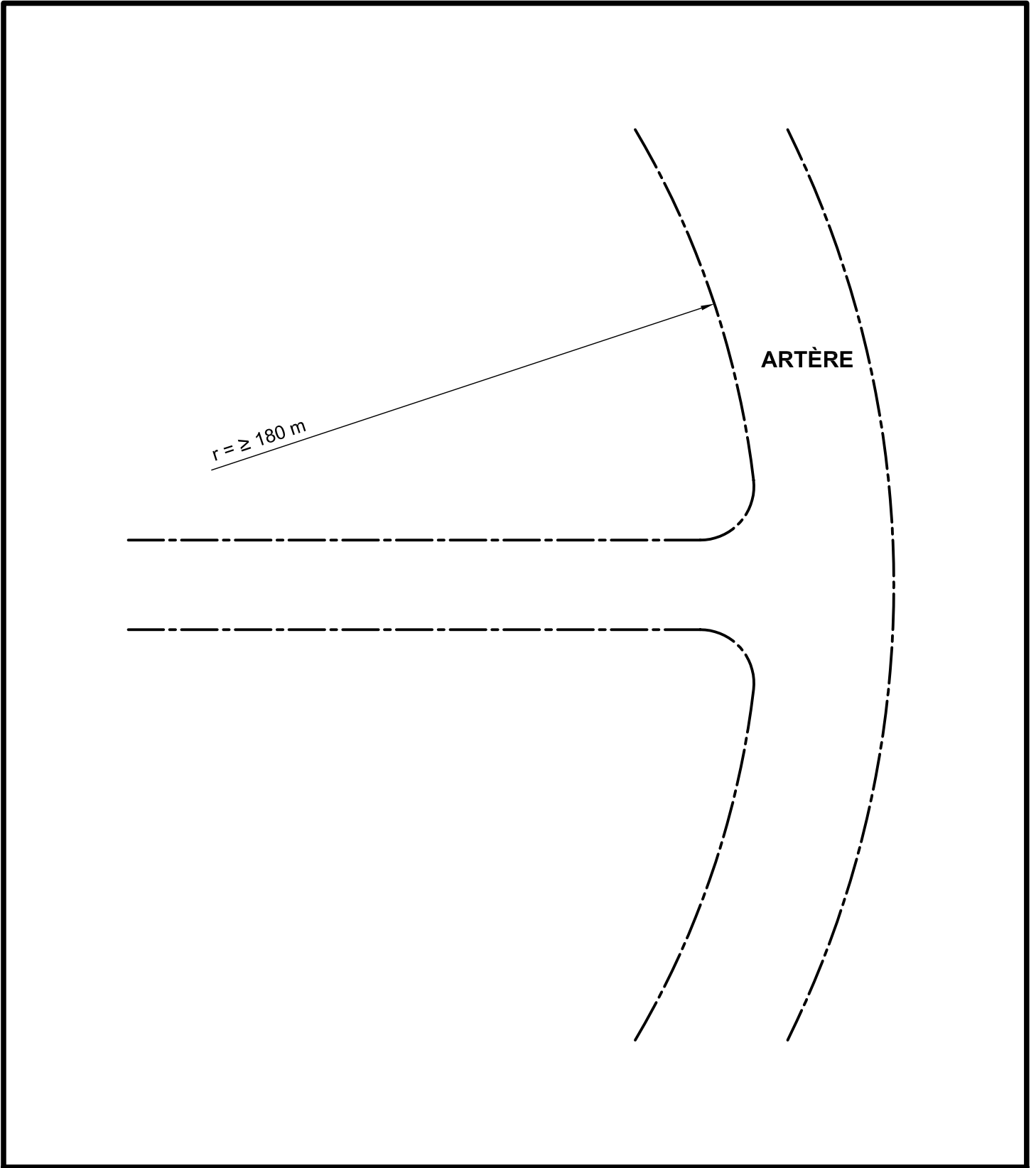

 VILLE DE SAINT-JÉRÔME	<u>Description</u> INTERSECTIONS Distance à respecter entre les voies de circulation		
	<u>Règlement</u> 0310 - Lotissement	<u>Illustration (n° article):</u> 31.1)5°b)	
<u>Annexe:</u> 1	<u>Plan no.:</u> 0310-000.7	<u>Échelle:</u> Aucune	<u>Date:</u> 2010-04-01

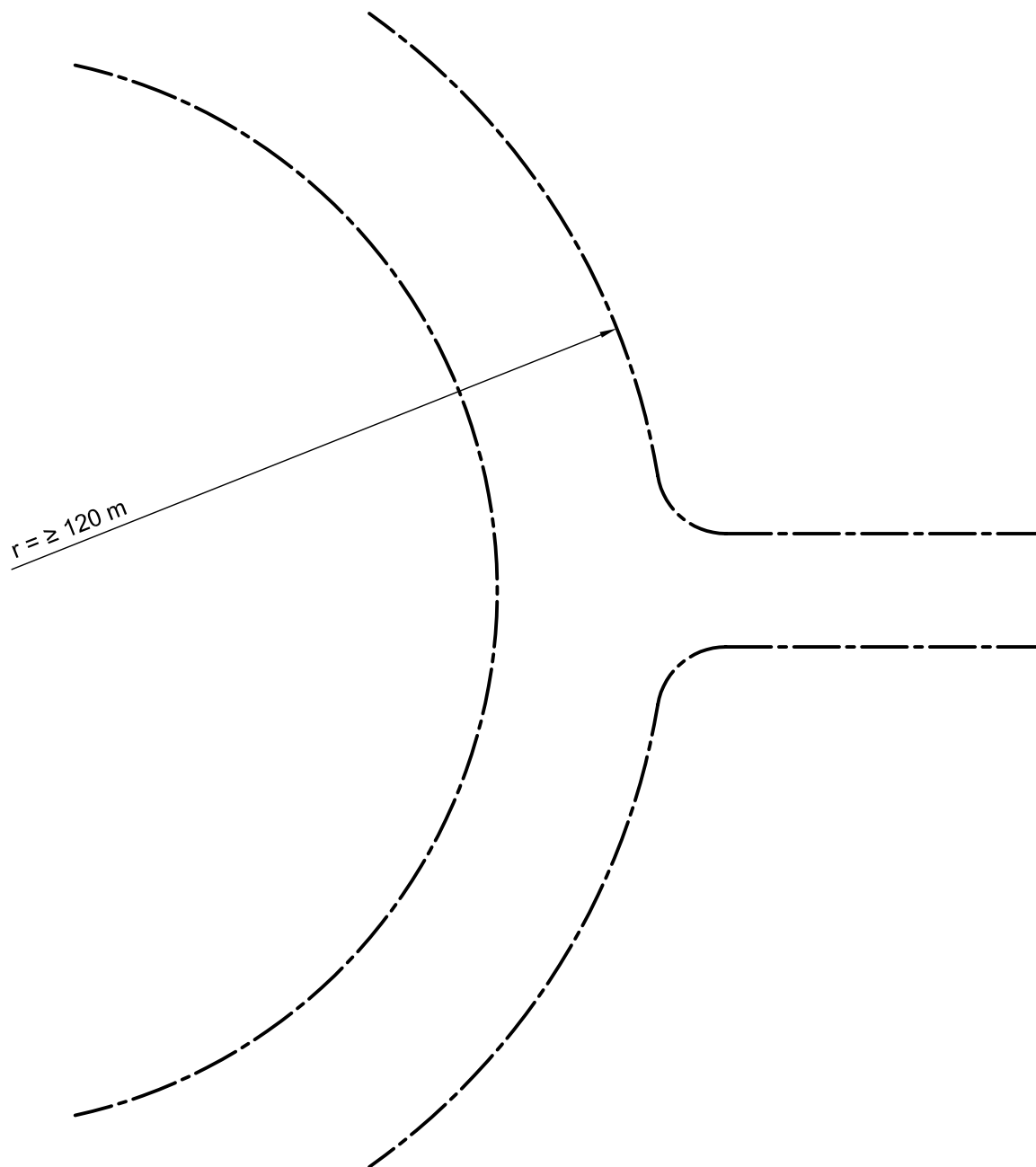

 VILLE DE SAINT-JÉRÔME	<u>Description</u> INTERSECTIONS Distance à respecter entre les voies de circulation		
	<u>Règlement</u> 0310 - Lotissement	<u>Illustration (n° article):</u> 31.1)5°c)	
<u>Annexe:</u> 1	<u>Plan no.:</u> 0310-000.8	<u>Échelle:</u> Aucune	<u>Date:</u> 2010-04-01

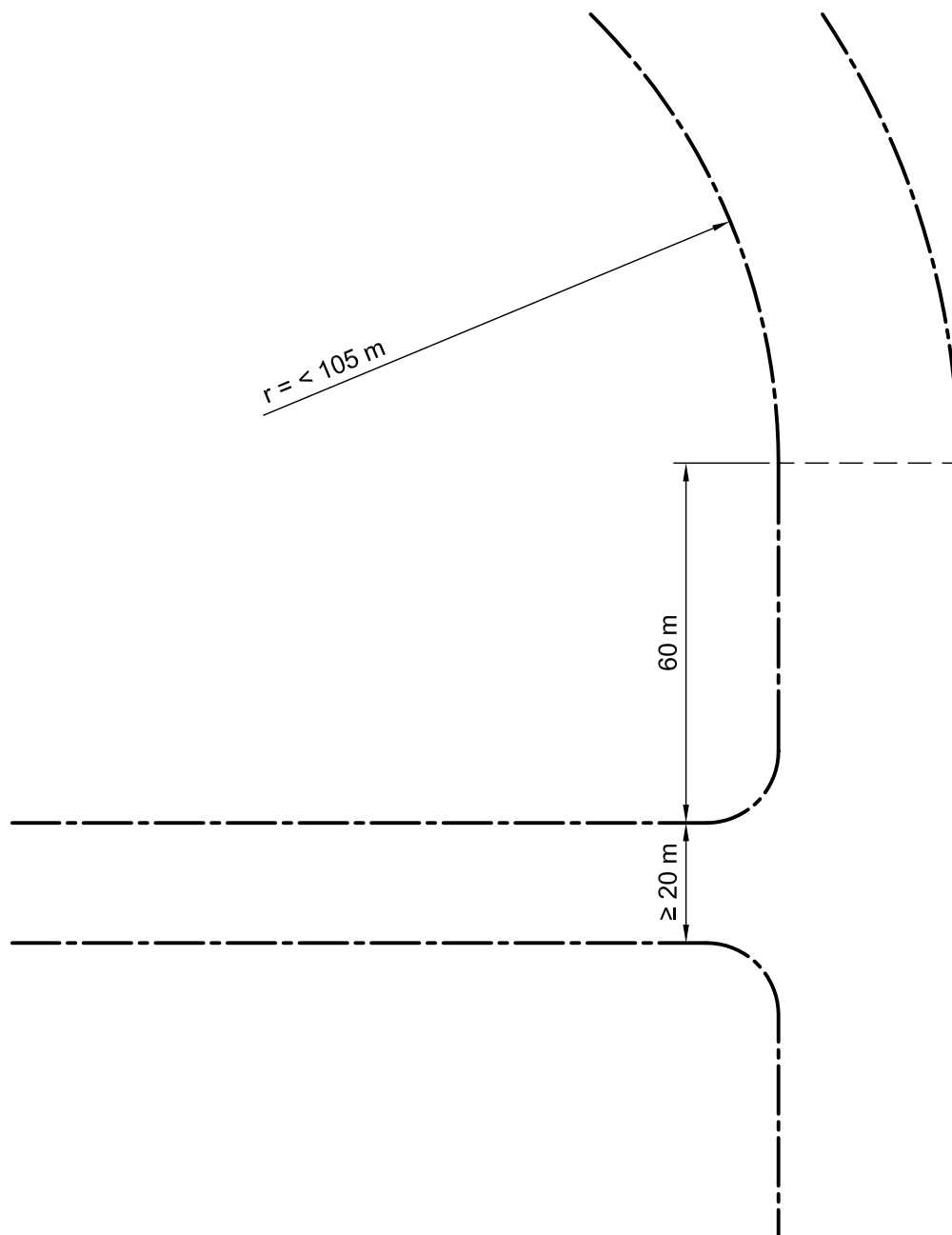

 VILLE DE SAINT-JÉRÔME	INTERSECTIONS Distance à respecter entre les voies de circulation		
	Règlement 0310 - Lotissement		Illustration (n° article): 31.1)6°
Annexe: 1	Plan no: 0310-000.9	Échelle: Aucune	Date: 2010-04-01

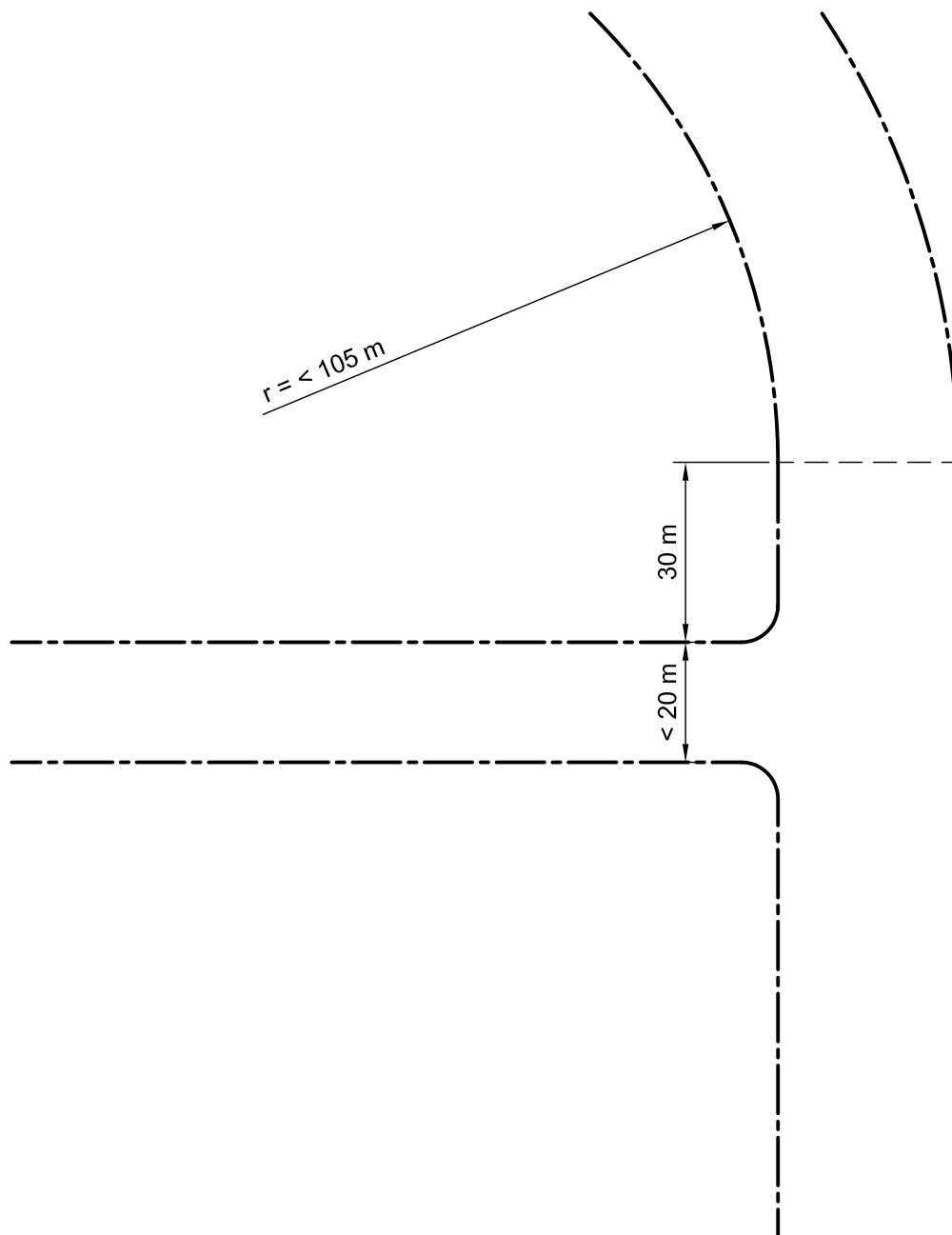

 VILLE DE SAINT-JÉRÔME	<u>Description</u> INTERSECTIONS Distance à respecter entre les voies de circulation		
	<u>Règlement</u> 0310 - Lotissement	<u>Illustration (n° article):</u> 31.1)7°	
<u>Annexe:</u> 1	<u>Plan no.:</u> 0310-000.10	<u>Échelle:</u> Aucune	<u>Date:</u> 2010-04-01

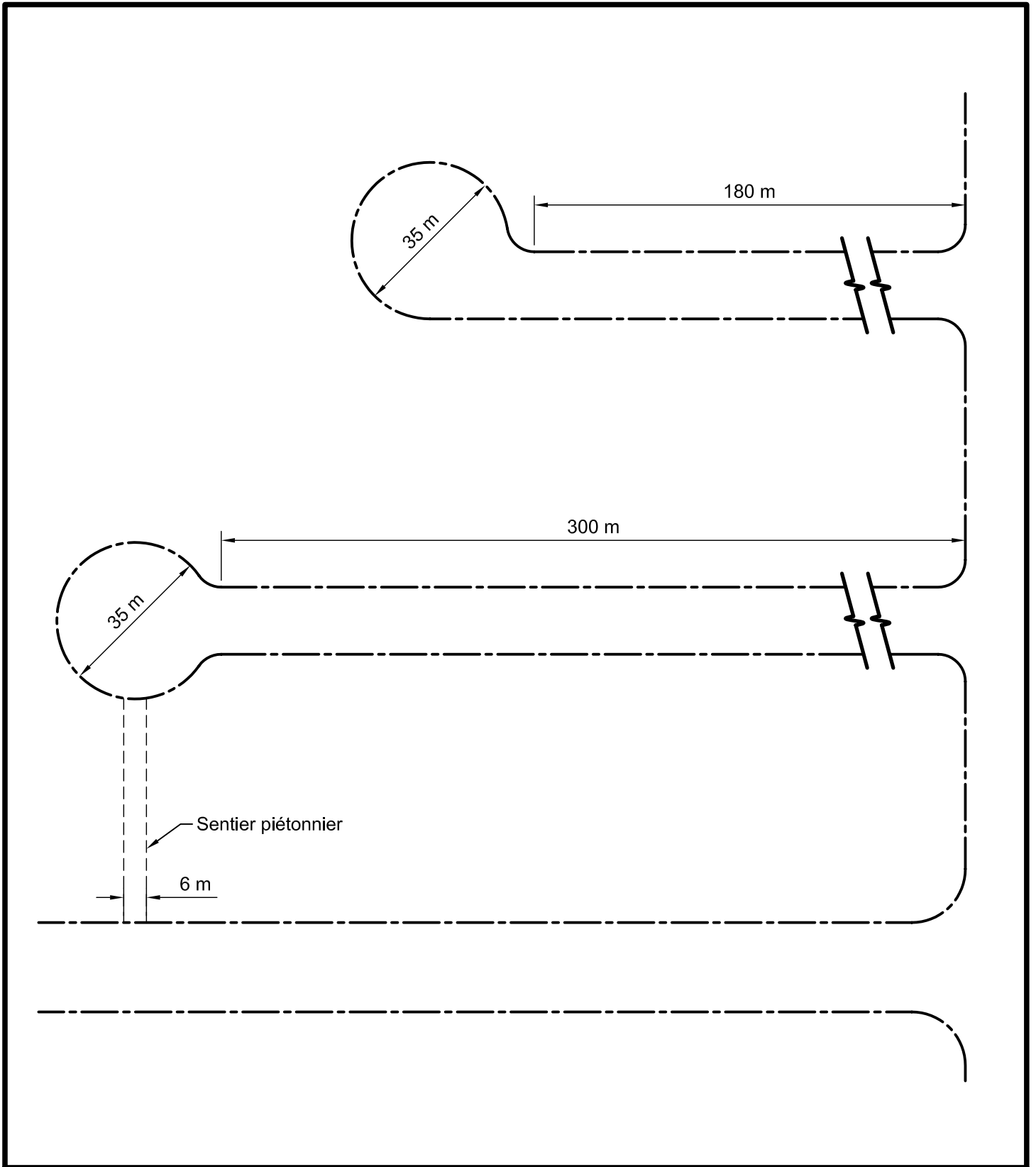

 VILLE DE SAINT-JÉRÔME	INTERSECTIONS Dispositions applicables à une rue sans issue de type "cul-de-sac"		
	Règlement 0310 - Lotissement	Illustration (n° article): 33	
Annexe: 1	Plan no: 0310-000.11	Échelle: Aucune	Date: 2010-04-01

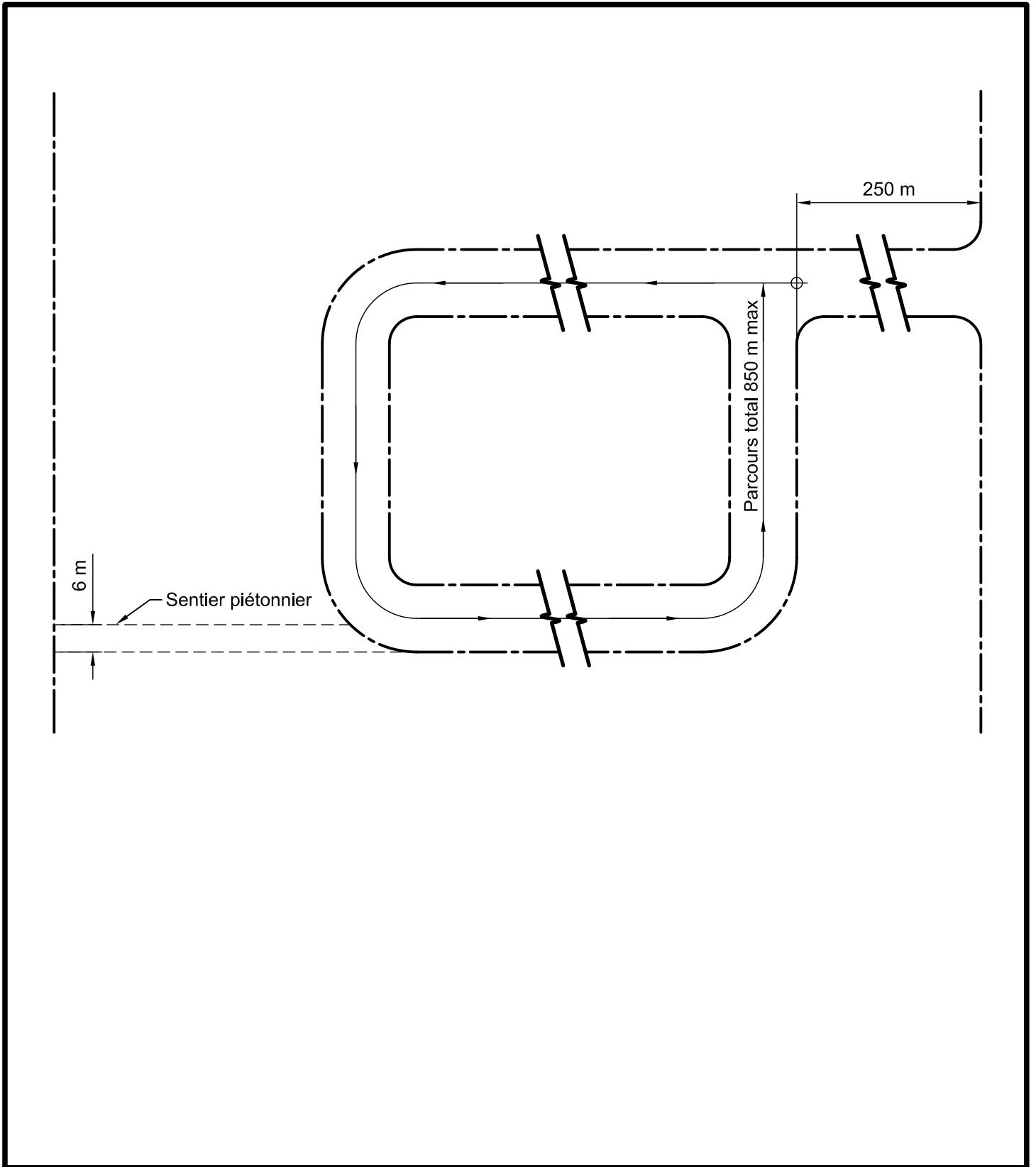

 VILLE DE SAINT-JÉRÔME	Description INTERSECTIONS Dispositions applicables à une rue sans issue de type "tête de pipe"		
	Règlement 0310 - Lotissement	Illustration (n° article): 34	
Annexe: 1	Plan no: 0310-000.12	Échelle: Aucune	Date: 2010-04-01

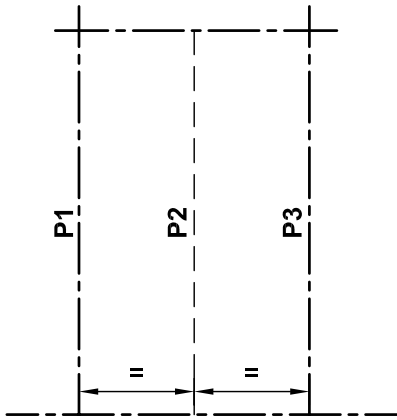

RUE

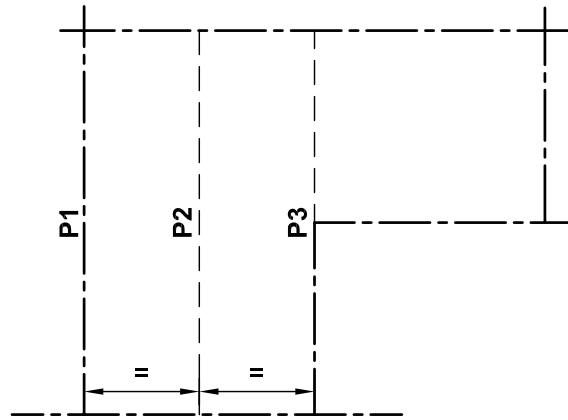

RUE

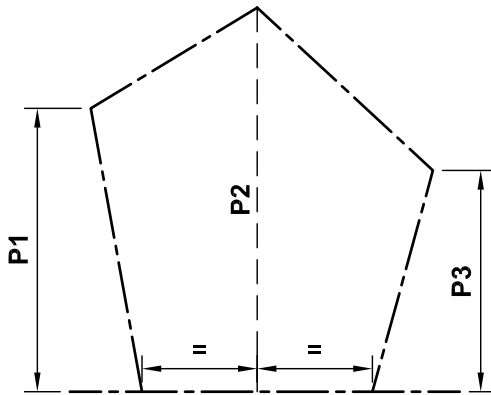

RUE

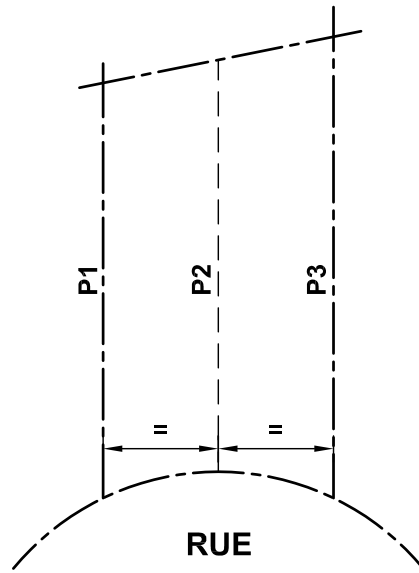

RUE

LÉGENDE	
P1	Ligne latérale gauche
P2	Ligne au centre de la ligne avant du terrain
P3	Ligne latérale droite

P = Profondeur du lot
$P = \frac{P1 + P2 + P3}{3}$



Description	TERRAINS		
	Calcul de la profondeur d'un terrain		
Règlement	0310 - Lotissement		Illustration (n° article): 39.1)
Annexe: 1	Plan no: 0310-000.13	Échelle: Aucune	Date: 2010-04-01

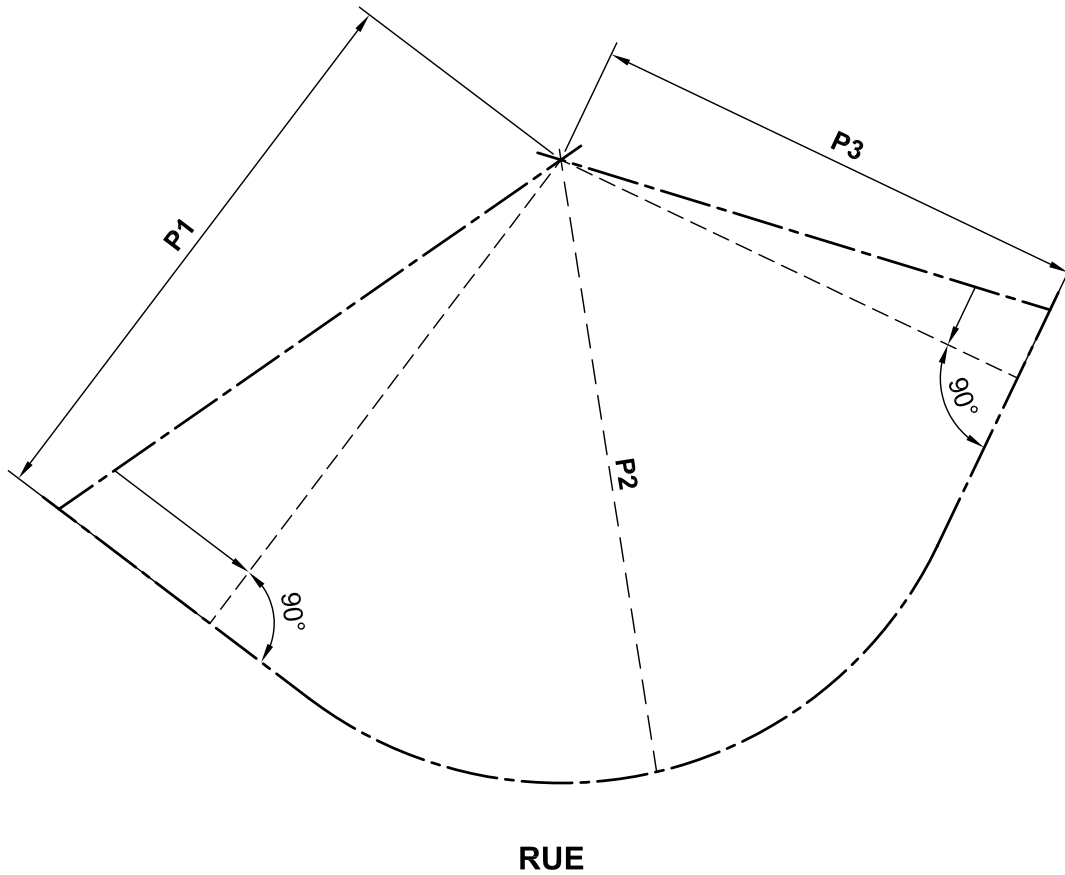

LÉGENDE	
P1	Ligne latérale gauche
P2	Ligne au centre de la ligne avant du terrain
P3	Ligne latérale droite

P = Profondeur du lot
$P = \frac{P1 + P2 + P3}{3}$

 VILLE DE SAINT-JÉRÔME	<u>Description</u> TERRAINS Calcul de la profondeur d'un terrain		
	<u>Règlement</u> 0310 - Lotissement	<u>Illustration (n° article):</u> 39.2)	
<u>Annexe:</u> 1	<u>Plan no.:</u> 0310-000.14	<u>Échelle:</u> Aucune	<u>Date:</u> 2010-04-01

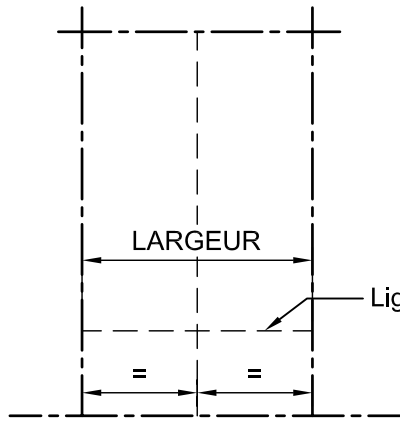

RUE

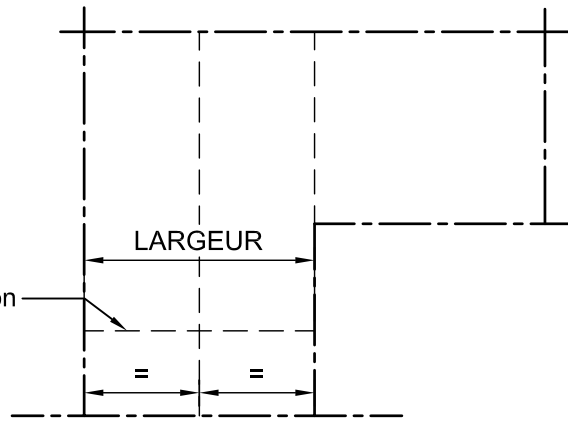

RUE

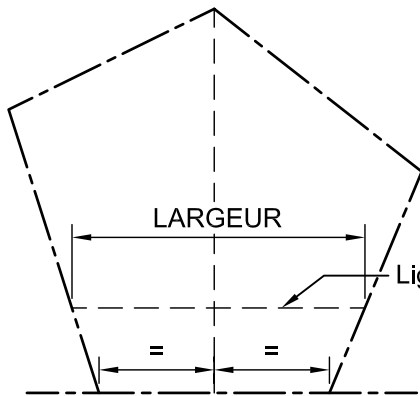

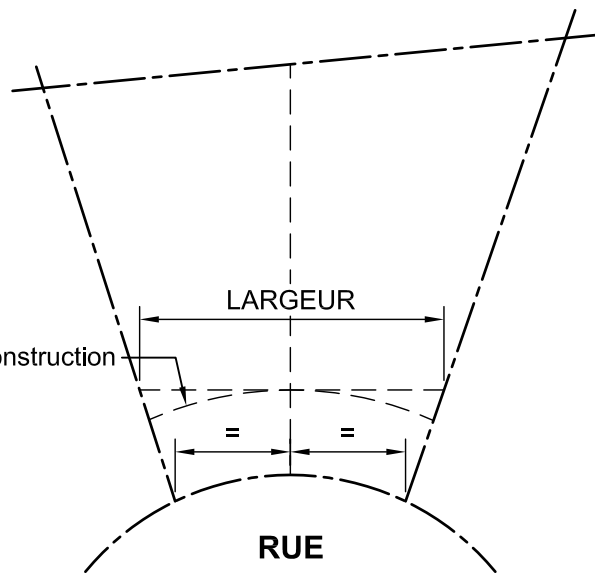

RUE

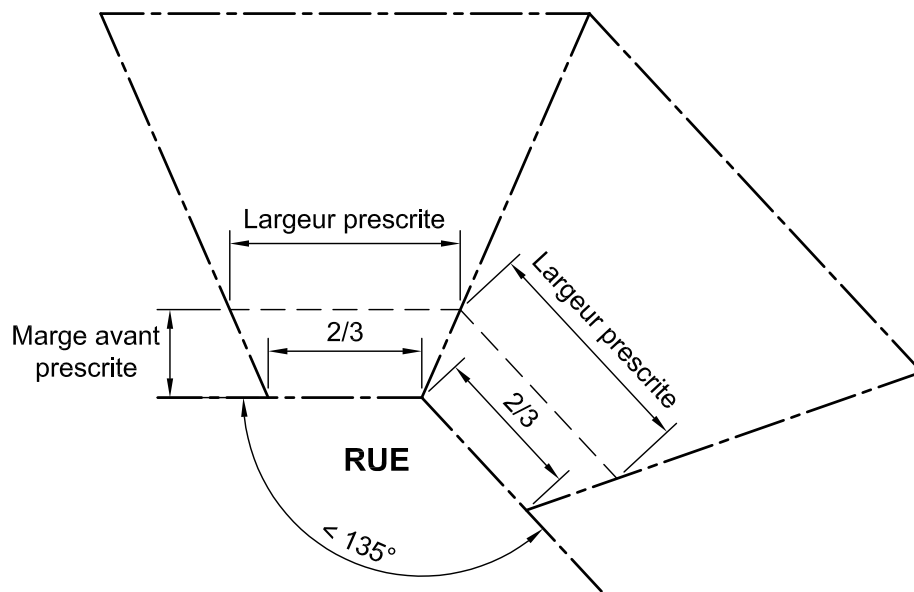

RUE

 VILLE DE SAINT-JÉRÔME	<u>Description</u> <p style="text-align: center;">TERRAINS Calcul de la largeur d'un terrain</p>		
	<u>Règlement</u> <p style="text-align: center;">0310 - Lotissement</p>		<u>Illustration (n° article):</u> <p style="text-align: center;">40</p>
<u>Annexe:</u> <p style="text-align: center;">1</p>	<u>Plan no.:</u> <p style="text-align: center;">0310-000.15</p>	<u>Échelle:</u> <p style="text-align: center;">Aucune</p>	<u>Date:</u> <p style="text-align: center;">2010-04-01</p>



	Description TERRAINS Terrains situés sur la ligne extérieure d'une courbe		
	Règlement 0310 - Lotissement	Illustration (n° article): 46	
Annexe: 1	Plan no: 0310-000.16	Échelle: Aucune	Date: 2010-04-01